

Solar PV Array Based Water Pumping By Using BLDC Drive

Mr. Pitale Kalidas B.¹, Prof. S.M Kulkarni²

^{1,2}Dept of Electrical Power System

^{1,2}PES COLLEGE OF ENGINEERING AURANGABAD.

Abstract- *The generation of exact commutation to start the permanent magnet brushless direct current (PMBLDC) motor in position sensorless control mode is the most challenging task. A peak current detection starting algorithm based wide speed range position sensorless control for solar photovoltaic array fed PMBLDC motor drive for the irrigation water pumping is presented here. This starting algorithm controls the exact starting commutation along with the peak starting current. An elimination of position sensor and current sensor for rotor position estimation makes the implemented drive compact and cost effective for agricultural application. The operation of the drive is first tested with simulation and the reliability is tested in the laboratory prototype as well as in compact industrial product prototype with cost-effective digital signal processor. The robustness of the system is verified with different simulation and test results at various operating conditions. The compact cost-effective solution fits perfect for low cost, demanding both irrigation and domestic water pumping.*

Keywords- Incremental conductance (INC) maximum power point tracking (MPPT) algorithm, peak current detection based starting, permanent magnet brushless direct current (PMBLDC) motor drive, position sensorless control, water pumping

I. INTRODUCTION

first feeds the PV energy into the utility grid through a grid inverter and a water pump is then fed by that utility grid through a pump inverter. Although being a grid connected PV pumping system, it appears as a system operated by utility grid only. A kind of hybrid PV water pumping is presented in [15], wherein a battery is first charged by PV array through a charge controller and then it is discharged to feed the water pump via an inverter. The pump is also supported by a utility interface through an option switch. This system becomes expensive due to an added manufacturing and maintenance cost of the battery storage. A part of the PV installation is engaged in water pumping and the remaining part in feeding power to the grid in [16-17]. The system is not reliable as the pumping is dependent only on the PV energy and no power is drawn from the utility. A grid

interfaced PV fed-BLDC motor driven water pumping with unidirectional power flow control is developed in [18], wherein the remaining power is drawn from the grid whenever required. The developed system fails to utilize the PV power in case the water pumping is not required. All these aforementioned existing topologies of a PV based pumping systems present a unidirectional power flow control which either feeds the grid or draws power from the grid. A multifunctional system which may enable a bi-directional power flow depending on the operating circumstances such that both PV installation and pumping system are fully utilized, is yet to be developed. This work presents suchlike system employing first-time a BLDC motor drive. As mentioned, the proposed system deals with the development of a bi-directional power flow control, enabling the flow of power from PV array to the single phase utility grid in case a water pumping is not required, and from the grid to BLDC motor-pump in case the PV array power is not sufficient (or at night) to run the pump at its full capacity. This practice offers a source of earning to the consumers by sale of electricity to the utility. A unit vector template (UVT) generation, due to its simplicity and ability to serve the objective, is applied to perform a bi-directional power transfer. The proposed system also meets the power quality standards required by a utility grid as per IEEE-519 standard [19]. A grid interfaced PV based water pumping system, incorporating some of the aforementioned features, has been reported in [20]. A detailed design approach, control methodology, simulation analysis and hardware implementation are added here.

II. DESIGN OF SOLAR PV ARRAY

An SPV array of 1.5 kW peak power capacities is preferred in such approach that the interpretation of the scheme is not affected by the losses connected in the midst of the converters. The parameters of the SPV array are estimated at the standard solar isolation level of 1000 W/m^2 . As irradiance value changes it affects power and thus efficiency of the system is get affected, thus efficiency of the system is reduced.

Table I. Design of Solar PV array

For a PV Array	
Parameters	Values
Open circuit Voltage	20.76V
Short circuit current	6.22A
Temperature	25 °C
Irradiance level	1000
For a PV Array	
Voltage at MPP	248.5
Power at MPP	1550W
Current at MPP	1550/248.5=6.23A
Number of cell connected in series	248.5/20.76=12
Number of cell connected in parallel	6.22/5.59=1

III. MPPT ALGORITHM

The MPPT proficiency is generally used to amend maximum benefits that is maximum efficiency in solar PV planted application. In this paper, incremental conductance MPPT controller is used which gives smooth and fast tracking Performance under any atmospheric condition. This MPPT gives better performance than P and o algorithm. The INC conductance MPPT is tracked via evaluating existing conductance with next incremental conductance. From incremental conductance flowchart [8], current and voltage are output of solar PV array at any time. The duty cycle of boost converter play very important role in order to gets maximum benefits from solar PV array. When solar PV voltage become constant after particular point, output current is going to increases, then duty ratio is also improved. If current declines then duty ratio falls. In generally, main purpose of algorithm is to look towards the appropriate duty cycle in which incremental conductance becoming instantaneous conductance due to that PV system is always operated around MPP. ΔD is incremental size which helps to determine how fast MPP is going to tracked , grater size ΔD fast tracking will be achieve. The major benefits of incremental conductance are that it can generate superior results beneath quickly changing environment condition. For tracking the maximum power from PV system, various methods have been developed over the decade which involves simple voltage and current relations. For this research work, Incremental Conductance algorithm is chosen due to its superiority over other algorithms.

Incremental conductance

This MPP algorithm is based on the fact that at the Maximum power point, the P-V curve slope is zero. The

power obtained from the PV is differentiated with respect to voltage.

$$\frac{dP}{dV} = \frac{d(VI)}{dV} = I + V \frac{dI}{dV}$$

At MPP, the rate of change of power w.r. to voltage is zero

$$\frac{dI}{dV} = -\frac{I}{V}$$

The algorithm of the Incremental Conductance works by comparing the incremental conductance $\frac{dI}{dV}$ with instantaneous conductance $-\frac{I}{V}$. Achieving the $\frac{dP}{dV} = 0$ is the control aim to achieve MPP of the array. Positive value of dP/dV refer that the operating region lies on the left hand side of MPPT and increase in array voltage would yield increase in power. Alternatively, negative value of dP/dV infers that the operating region had exceeded the MPPT and increase in voltage would reduce the power as shown in figure 2.11.

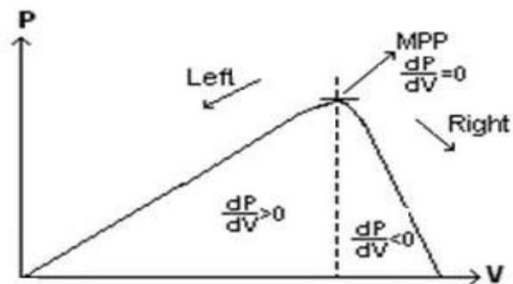

Figure 3.1 : P-V curve for IC

IV. SPEED CONTROL OF BLDC MOTOR

A BLDC motor is any of a class of electrical machines that converts direct current electrical power into mechanical power. The most common types rely on the forces produced by magnetic fields. early all types of BLDC motors have some internal mechanism, either electromechanical or electronic, to periodically change the direction of current flow in part of the motor. Most types produce rotary motion; a linear motor directly produces force and motion in a straight line.

The proposed BLDC motor drive eliminates the phase current sensors. It is desired to operate the BLDC motor-pump at its rated speed irrespective of the climatic condition. This is achieved by continuously

regulating the DC bus voltage of VSI at the rated DC voltage of BLDC motor. A bi-directional power flow control enables, by regulating the DC bus voltage and hence the operating speed, to deliver a full amount of power required to pump the water with full capacity. In case the grid is not available, the DC bus voltage is not maintained at the rated DC voltage of BLDC motor under bad climatic conditions, and the speed is governed by a variable DC bus voltage.

V. PROPOSED SCHEME

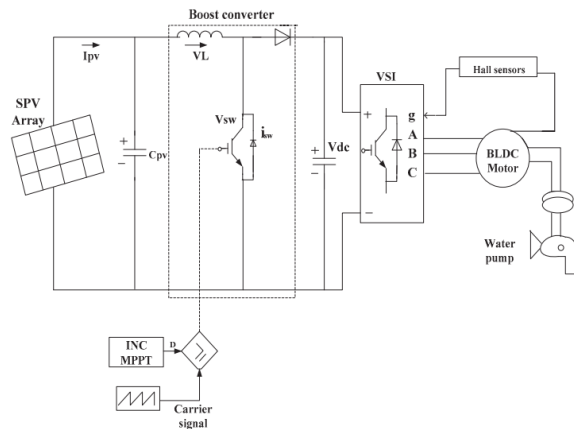

Fig. 5.1 Configuration of the SPV array fed BLDC motor driven water pumping system.

Fig.5.1 shows the proposed system configuration, in which BLDC motor is used for pumping system, BLDC motor is operated by voltage source inverter of DC-link. The proposed system gives energy from solar PV based boost converter for pumping load. Solar PV array generates energy gives to the boost converter; the switch of the boost converter is operated by MPPT algorithm such that maximum benefits from solar PV array is optimized and also gives smooth performance of BLDC motor for pumping application. The hall sensors are used in order to sense rotor position of motor. Hall sensors are electronically commutated circuit used for inverter switching.

VI. BI-DIRECTIONAL POWER FLOW CONTROL

The development of a reliable water pumping system and full utilization of the resources are realized by a grid interactive PV generation. To allow the flow of power in either direction, a bi-directional power control based on a UVT generation [20, 27-28] is applied as shown in Fig. 2. This is the simplest technique and is easy to implement as it does not require any complex mathematical model or algorithm. A single phase PLL (Phase Locked Loop) is used to synchronize the utility grid voltage and current. It generates a sinusoidal unit vector of supply voltage, $\sin \theta$ at fundamental

frequency. On the other hand, an amplitude of fundamental component of supply current, I_{sp} is extracted by regulating the DC bus voltage, v_{dc} .

A proportional-integral (PI) controller is used as a voltage regulator. V_{dc} is sensed and passed through a first-order low pass filter to suppress the ripple contents. The filtered v_{dc} is then compared with a set value, V_{dc}^* . A fundamental component of supply current, i_{s}^* is extracted by multiplying I_{sp} and $\sin \theta$. The sensed supply current, i_s is compared with i_{s}^* and error is processed through a current controller to generate the gating pulses for VSC. When it is required to draw power from utility, the voltage regulator generates a positive I_{sp} . Therefore, an in-phase supply current is drawn from the grid. Likewise, when the utility is fed by PV array, a negative I_{sp} is generated resulting in an out-of-phase supply current. Thus, by reversing the direction of current, direction of power flow is controlled as per the requirement. An improved power quality at the utility grid is also ensured by the applied control technique in terms of total harmonic distortion (THD) and power factor. In case the grid is not available, the DC bus voltage cannot be regulated. Nevertheless, the PV array is able to feed the water pump in standalone mode although being sensitive to the climatic condition. The detailed analysis of proposed bidirectional power flow control is given in Appendices.

VII. SIMULINK MODEL

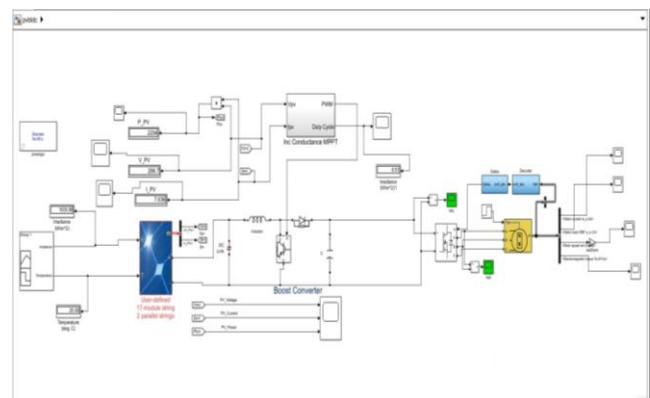

Fig.7.1 Simulink model for solar powered brushless dc motor drive for water pumping system

the proposed system configuration, in which BLDC motor is used for pumping system, BLDC motor is operated by voltage source inverter of DC-link. The proposed system gives energy from solar PV based boost converter for pumping load. Solar PV array generates energy gives to the boost converter; the switch of the boost converter is operated by MPPT algorithm such that maximum benefits from solar PV array is optimized and also gives smooth performance of BLDC motor for pumping application. The hall sensors are

used in order to sense rotor position of motor. Hall sensors are electronically commuted circuit used for inverter switching.

Performance of the simulated system is shown below. The proposed system is simulated in MATLAB; following results are obtained, as shown below. The proposed system consist output of solar PV array, inverter, converter and BLDC motor pumping output. Each section results is extracted from proposed system by using MATLAB /Simulink. The simulated results are shown below

Solar PV System Power Output

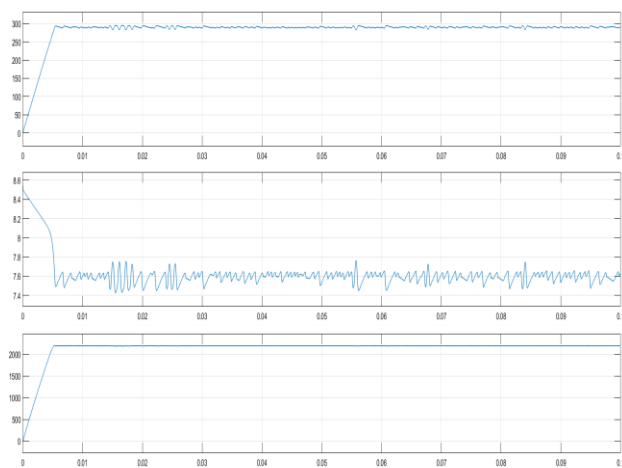

Solar PV System Volatage

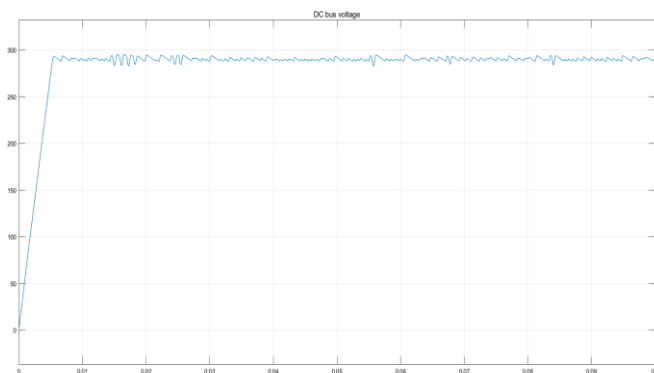

SIMULATION RESULTS FOR SPEED CONTROL OF BLDC MOTOR :

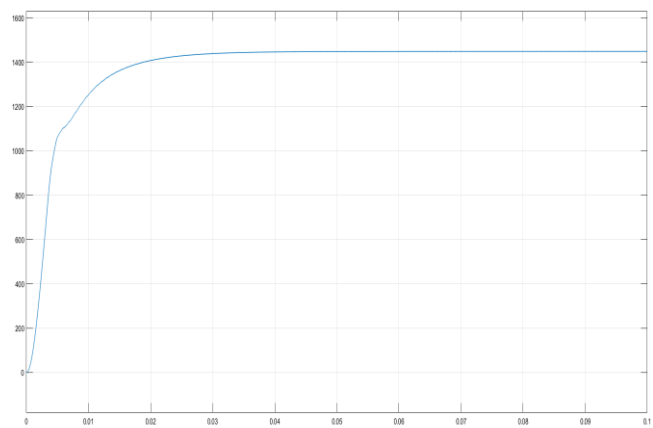

The following proposed system gives benefits of solar PV based application driven by BLDC motor for water pump as shown infig.1. There are various ways to control speed of BLDC motor like hysteresis control and other control scheme are used. But following configuration is simple, low cost, noise free and having least component of the system; make configuration is suitable for water pumping system.

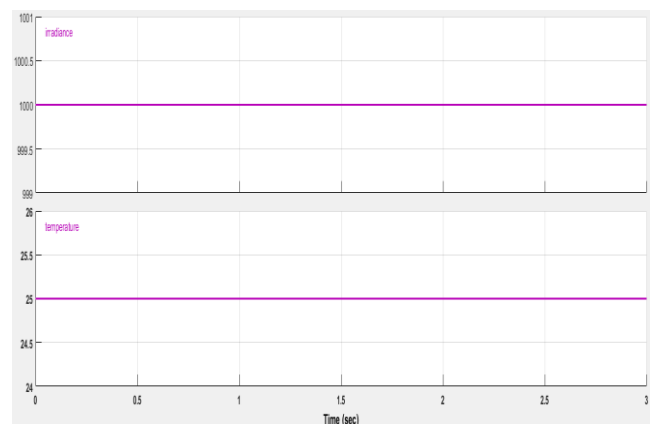

Fig. 6.2 Solar Irradiance and Temperature

The PV array output is shown in figure 6.2. For the given input of PV array the output is observe. In figure 6.2, it clearly seen that the solar irradiance is kept for 1000 W/m² and Temp 25°C for better efficiency of the panel. The PV array output voltage is obtained is near to 290 V and output current is near to 7.59 A so the PV array is designed at rated power output of 2.2 kW.

In this waveform Generally boost converter is used to operate system at higher voltage level. Proper design of converter helps for proper utilization of the system. As due to the only switch of boost converter had extremely excellent renovation efficiency. Boost converter helps to determine maximum power from solar PV array. Voltage of SPV array at maximum point is $V_{pv} \cong 5.248$, as source of input voltage, and V_{dc} is dc output voltage of boost converter, the input–output relationship of boost converter.

VII. CONCLUSION

The DC-DC boost converter gives reliable trapping as well as efficient from SPV panel by using suitable incremental conductance MPPT algorithm is properly tracked. The MPPT tracking gives result along with little bit drop which fed to inverter gives exact result to inverter then inverter output fed to BLDC Motor. The proposed system gives smooth and soft starting of BLDC motor. The proposed system having centrifugal pump load gives smooth speed and power performances of BLDC Motor.

REFERENCES

- [1] M. T. A. Khan, G. Norris, R. Chattopadhyay, I. Husain and S. Bhattacharya, "Autoinspection and Permitting With a PV Utility Interface (PUI) for Residential Plug-and-Play Solar Photovoltaic Unit," *IEEE Trans. Ind. Appl.*, vol. 53, no. 2, pp. 1337-1346, March-April 2017.
- [2] M. Montorfano, D. Sbarbaro and L. Morán, "Economic and Technical Evaluation of Solar-Assisted Water Pump Stations for Mining Applications: A Case of Study," *IEEE Trans. Ind. Appl.*, vol. 52, no. 5, pp. 4454-4459, Sept.-Oct. 2016.
- [3] Billel Talbi, Fateh Krim, Toufik Rekioua, Saad Mekhilef, Abdelbaset Laib and Abdesslam Belaout, "A high performance control scheme for photovoltaic pumping system under sudden irradiance and load changes," *Solar Energy*, vol. 159, pp. 353-368, 2018.
- [4] Packiam Periasamy, N.K. Jain and I.P. Singh, "A review on development of photovoltaic water pumping system," *Renewable and Sustainable Energy Reviews*, vol. 43, pp. 918-925, March 2015.
- [5] R. Kumar and B. Singh, "BLDC Motor Driven Solar PV Array Fed Water Pumping System Employing Zeta Converter," *IEEE Trans. Ind. Appl.*, vol. 52, no. 3, pp. 2315-2322, May-June 2016.
- [6] Bhim Singh and Rajan Kumar, "Solar PV Array Fed Water Pump Driven By BLDC Motor Using Landsman Converter," *IET Renewable Power Generation*, vol. 10, no. 4, pp. 474-484, April 2016.
- [7] K. Rahrah, D. Rekioua, T. Rekioua and S. Bacha, "Photovoltaic pumping system in Bejaia climate with battery storage," *International Journal of Hydrogen Energy*, vol. 40, no. 39, pp. 13665-13675, 19 October 2015.
- [8] Abla Khiareddine, Chokri Ben Salah and Mohamed Faouzi Mimouni, "Power management of a photovoltaic/battery pumping system in agricultural experiment station," *Solar Energy*, vol. 112, pp. 319-338, February 2015.
- [9] Sara Ghaem Sigarchian, Anders Malmquist and Torsten Fransson, "Modeling and Control Strategy of a Hybrid PV/Wind/Engine/Battery System to Provide Electricity and Drinkable Water for Remote Applications," *Energy Procedia*, vol. 57, pp. 1401-1410, 2014.
- [10] A. Khiareddine, C. Ben Salah and M. F. Mimouni, "Strategy of energy control in PVP/battery water pumping system," *International Conference on Green Energy, Sfax*, 2014, pp. 49-54.
- [11] J. H. Ugale and M. S. Panse, "Single phase AC drive for isolated solar photovoltaic water pumping system," *International Conference on Green Computing and Internet of Things (ICGCIoT)*, Noida, 2015, pp. 1285-1287.
- [12] A. Boussaibo, M. Kamta, J. Kayem, D. Toader, S. Haragus and A. Maghet, "Characterization of photovoltaic pumping system model without battery storage by MATLAB/Simulink," *9th International Symposium on Advanced Topics in Electrical Engineering (ATEE)*, Bucharest, 2015, pp. 774-780.