

Thermal Performance of Heat Pipe At Different Filling Ratio, Power, Coolant Mass Flow Rate, Inlet Temperature

S.T.Londhe¹, Dr.J.A.Hole², H.T.Magar³

^{1,2,3}Dept of Mechanical Engineering

^{1,2,3}RajashriShahu College of Engineering, Tathwade, Pune

Abstract- Heat pipes are efficient and low cost heat exchange equipment. The most amazing feature of the heat pipe is that have no any moving parts and little maintenance. Refrigerant R-134a is better substitute for R-22 and R-12 due to its environmental friendly nature. The thermal analysis of R-134a filled thermosyphon was investigated. The effect of filling ratio, coolant mass flow rate, input power supply and inlet Temperature on the performance of thermosyphon were investigated. The experimental result indicated that the efficiency of thermosyphon increased with increasing mass flow rate, fill ratio, and Temperature difference between inlet Temperature and outlet Temperature of Condenser section.

Keywords- efficient, heat pipe, thermosyphon, mass flow rate

I. INTRODUCTION

A heat pipe has been proved as a promising heat transfer device with good reliability and cost effectiveness. A two phase thermosyphon is widely used high performance heat transfer device which is used to transfer a large amount of heat with small Temperature difference.

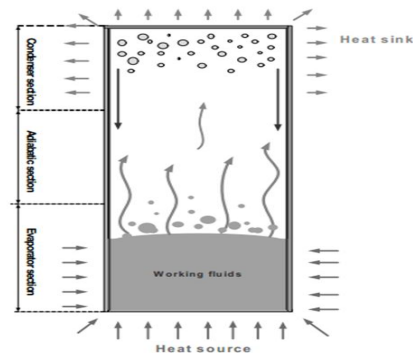

Fig.1 Cross section of heat pipe

there are three section, evaporative section, vapour or adiabatic section, Condenser section. Heat get added in evaporator section. Due to heat the working fluid present in heat pipe boils and get converted in to vapour. As vapour has low density it travels to the Condenser section. In condenser the vapor rejects its latent heat and gets converted in to liquid. Due to its weight the liquid moves downward and gets collected in evaporative section. And thus the cycle continues. Two phase closed thermosyphon is mostly used because of their simple structure. That's why, thermosyphons are used by many applications like: heat exchanger(pre-heaters),cooling of electronic equipments, in spacecraft, in solar energy etc.

II. EXPERIMENTAL SET-UP

The heat pipe is fabricated using a copper tube of 720 mm length and 17.1 mm inner diameter and 19 mm outer diameter. Ni-Cr wire having length 900 mm was used to make a heater of 230V, 400W capacity and heater was used for providing the required heat source at the evaporator. The evaporator and adiabatic sections of the heat pipe are insulated using glass wool to minimize the heat loss through these

Nomenclature:

l_e Length of evaporator section (m)
 l_c Length of Condenser section (m)
 D_i Inner diameter of heat pipe (m)
 T_i Inlet coolant water Temperature (K)
 T_o Outlet coolant water Temperature (K)
 T_e Average Temperature of evaporator section (K)
 T_c Average Temperature of Condenser section (K)
 T_v Saturation Temperature of refrigerant (K)
 Q_p Flow rate of water (litre/s)

M_w Mass flow rate of water (kg/s)
 Q_c Heat transfer at Condenser section (W)
 Q_e Heat transfer at evaporator section (W)
 ρ Density of water (Kg/m^3)
 R_{exp} Experimental thermal resistance of heat pipe ($^{\circ}\text{C}$)
 C_p Specific heat of water (J/KgK)
 h_e Heat transfer coefficient of evaporator section ($\text{W/m}^2\text{K}$)
 h_c Heat transfer coefficient of Condenser section ($\text{W/m}^2\text{K}$)
 η Efficiency of system

portions. Verica and multimeter were provided to control and measure the power input respectively. K- Type thermocouple wires were used as Temperature sensors (the position of thermocouple 1 is 15 mm from the top, position of thermocouple 2, 3, 4, 5, 6, 7, 8 are respectively 135, 250, 360, 415, 505, 600 mm and 690 mm from the top). A simple 10-channel digital Temperature indicator is used to measure the Temperature. The Condenser section consists of water jacket having two openings one for inlet and second for outlet. The bottom opening is for water inlet and upper opening is provided for water outlet. Thermocouples are provided at inlet and outlet opening to measure the Temperature of inlet and outlet water.

Inside of water jacket there is heat pipe is placed on which three k- type thermocouples are fixed. The adiabatic section separates the evaporator and Condenser sections on which two k-type thermocouples are fixed. Proper insulation is done using glass wool to prevent heat loss. In evaporator section heating of heat pipe is done using a heating coil of 400 watts.

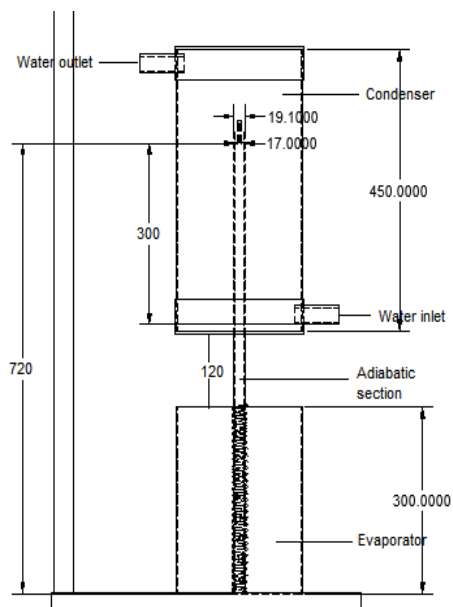

Fig.2. Schematic diagram of construction details of heat pipe.

K-type of thermocouples fixed on surface of heat pipe to measure the Temperature of surface and insulation is done using glass wool to prevent the heat loss. Eight thermocouple wires from Condenser, adiabatic and evaporator section are connected to data logger for live Temperature recording. Power supply to heating coil is supplied through dimmerstat for controlling the input power. Water is supplied using the water tank and flow rate is controlled using a valve. Water tank is used to maintain the Temperature of inlet water at 15 °C, 16 °C, 17 °C.

When power is supplied to heating coil the fluid inside (R134a) gets heated up. The evaporation of the fluid gets started. As the heating process started the natural convection occurs. The heated vapour of R134a starts moving upwards they reach the adiabatic section where Temperature is constant. Above that there is Condenser section at which heat rejection process is taking place as the water is flowing inside the water jacket.

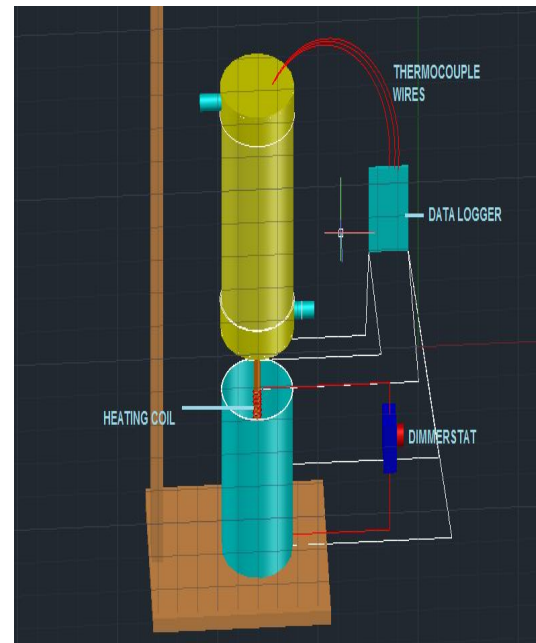

Fig.3. Schematic diagram of experimental setup

The transient tests were conducted on the heat pipe, in which heater was put on and the Temperature rise was observed at regular intervals till the steady state was achieved. After achievement of steady state the Temperatures at the eight points were noted. This experiment was repeated for different heat inputs (80W, 100W and 120W), different fill ratios (50%, 60% and 70%) and for different flow rates. For setting different flow rates calculate the time for filling 1 liter for 30 sec, 60 sec and 80 sec.

III. MATHEMATICAL MODEL

Flow rate of water

$$Q_v = \text{litre} / \text{x sec}$$

Mass flow rate of water

$$M_w = Q_v \times \rho$$

Heat transfer by water

$$Q_w = M_w \times C_p \times \Delta T$$

ΔT is inlet and outlet water Temperature difference.

$$\Delta T = (T_o - T_i)$$

Heat transfer by water is nothing but heat transfer by Condenser section

$$Q_w = Q_c$$

Thermal resistance of heat pipe

$$R_{exp} = T_e - T_c / Q_c$$

Heat transfer coefficient of evaporator section

$$h_e = \frac{Q_e}{\pi D_i l_e (T_e - T_v)}$$

Heat transfer coefficient of Condenser section

$$h_c = \frac{Q_c}{\pi D_i l_c (T_w - T_c)}$$

Efficiency of the system

$$\eta = \frac{Q_c}{Q_e}$$

IV. RESULTS

The Temperature of three point on the evaporator section, two point in adiabatic section and thjree point on the Condenser section are simultaneously monitored to observe the Temperature distribution over the entire length of thermosyphon

A) Graphs of heat pipe having fill ratio 70%

Graph no-1, 2 and 3 present the variation of Temperature along the thermoyphon for an power 80 watt, filling ratio 70%, three different inlet Temperature (15°C, 16°C and 17°C) and three different mass flow rates (1lit/80sec, 1lit/60sec and 1lit/30sec) respectively.

From the figures the Temperature distribution of the thermosyphon in the evaporator section Is almost isothermal. Due to the coolant mass flow inside the cooling jacket, the Temperature distribution in the Condenser section was lower as expected.

Graph No.1Temperature distribution along the thermosyphon (fill ratio= 70%, mass flow rate= 1lit/80sec,1lit/60sec, 1lit/30sec, inlet Temperature=15°C, input power= 80 watt)

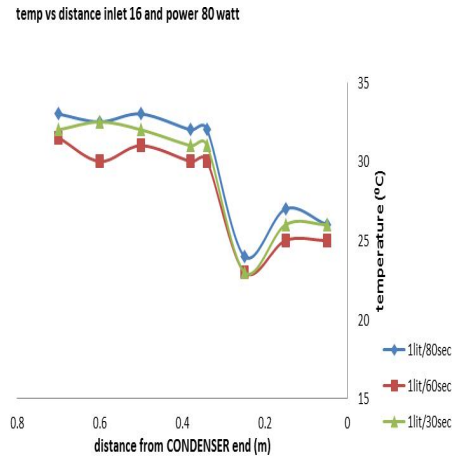

Graph No.2Temperature distribution along the thermosyphon (fill ratio= 70%, mass flow rate= 1lit/80sec,1lit/60sec, 1lit/30sec, inlet Temperature=16°C, input power= 80 watt)

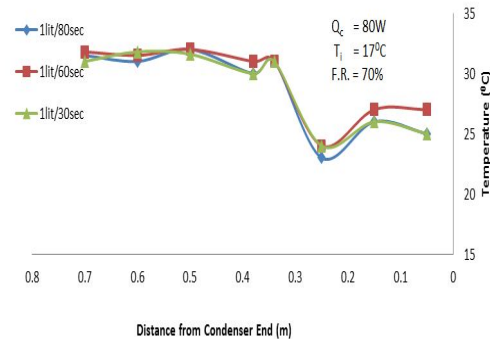

Graph No.3Temperature distribution along the thermosyphon (fill ratio= 70%, mass flow rate= 1lit/80sec,1lit/60sec, 1lit/30sec, inlet Temperature=17°C, input power= 80 watt)

Graph No.4, 5 and 6 present the variation of Temperature along the thermoyphon for an power 100 watt, filling ratio 70%, three different inlet Temperature (15°C, 16°C and 17°C) and three different mass flow rates (1lit/80sec, 1lit/60sec and 1lit/30sec) respectively.

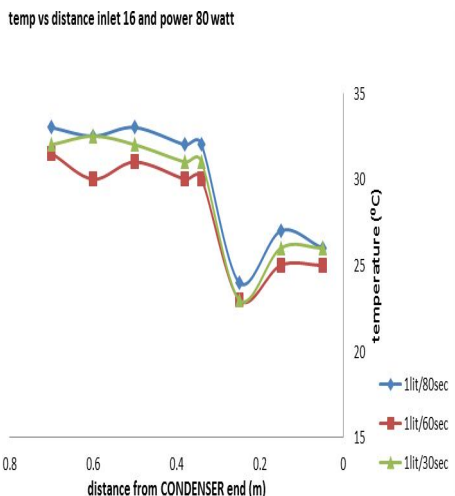

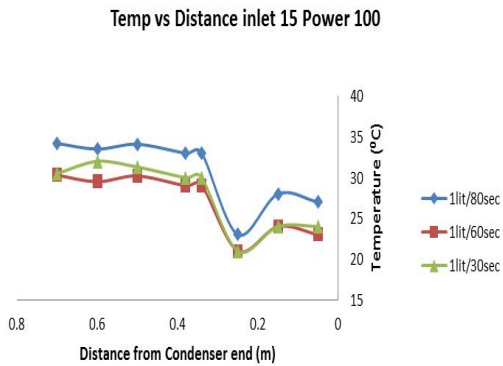

Graph No.4Temperature distribution along the thermosyphon (fill ratio= 70%, mass flow rate= 1lit/80sec,1lit/60sec, 1lit/30sec, inlet Temperature=15^oC, input power= 100 watt)

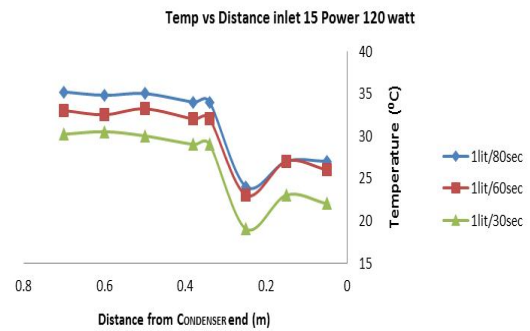

Graph No.7Temperature distribution along the thermosyphon (fill ratio= 70%, mass flow rate= 1lit/80sec,1lit/60sec, 1lit/30sec, inlet Temperature=15^oC, input power= 120 watt)

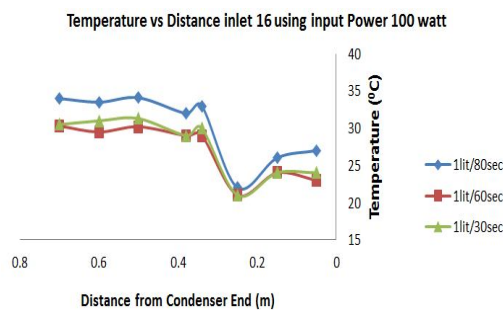

Graph No.5Temperature distribution along the thermosyphon (fill ratio= 70%, mass flow rate= 1lit/80sec,1lit/60sec, 1lit/30sec, inlet Temperature=16^oC, input power= 100 watt)

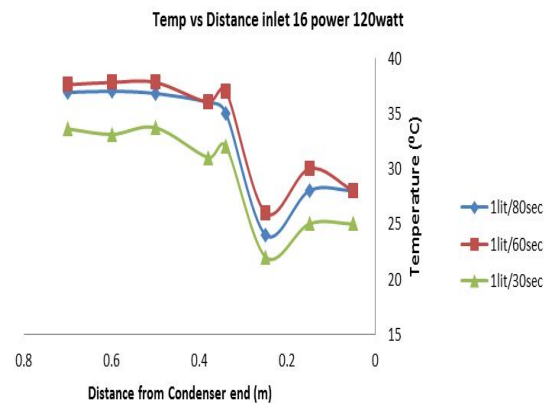

Graph No.8Temperature distribution along the thermosyphon (fill ratio= 70%, mass flow rate= 1lit/80sec,1lit/60sec, 1lit/30sec, inlet Temperature=16^oC, input power= 120 watt)

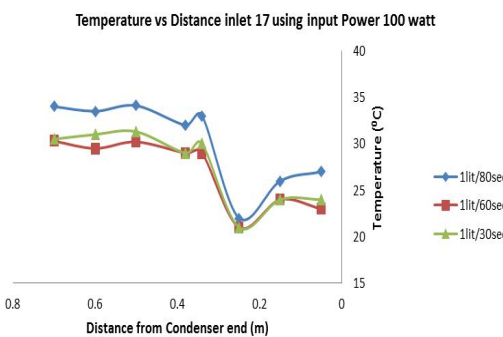

Graph No.6Temperature distribution along the thermosyphon (fill ratio= 70%, mass flow rate= 1lit/80sec,1lit/60sec, 1lit/30sec, inlet Temperature=17^oC, input power= 100 watt)

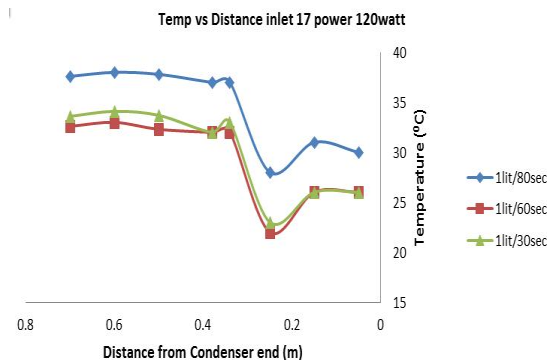

Graph No.9Temperature distribution along the thermosyphon (fill ratio= 70%, mass flow rate= 1lit/80sec,1lit/60sec, 1lit/30sec, inlet Temperature=17^oC, input power= 120 watt)

Graph No. 7, 8 and 9 present the variation of Temperature along the thermosyphon for an power 120 watt, filling ratio 70%, three different inlet Temperature (15^oC, 16^oC and 17^oC) and three different mass flow rates (1lit/80sec, 1lit/60sec and 1lit/30sec) respectively.

B)Graphs of heat pipe having fill ratio 60%

Graph No.10 , 11 and 12 present the variation of Temperature along the thermosyphon for an power 80 watt, filling ratio 60%, three different inlet Temperature (15°C, 16°C and 17°C) and three different mass flow rates (1lit/80sec, 1lit/60sec and 1lit/30sec) respectively.

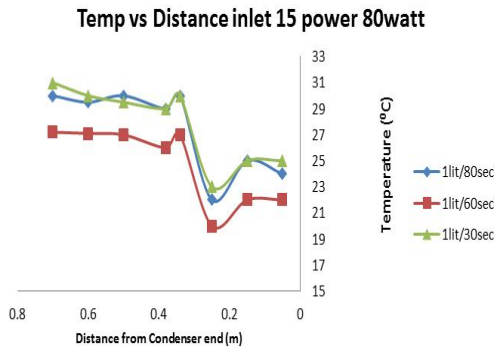

Graph No.10Temperature distribution along the thermosyphon (fill ratio= 60%, mass flow rate= 1lit/80sec,1lit/60sec, 1lit/30sec, inlet Temperature=15°C, input power= 80 watt)

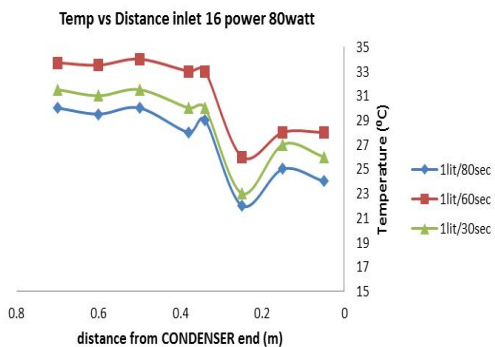

Graph No.11Temperature distribution along the thermosyphon (fill ratio= 60%, mass flow rate= 1lit/80sec,1lit/60sec, 1lit/30sec, inlet Temperature=16°C, input power= 80 watt)

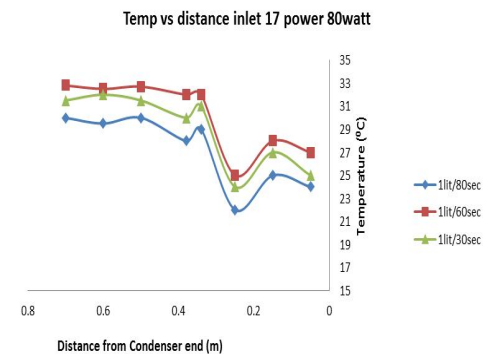

Graph No.12Temperature distribution along the thermosyphon (fill ratio= 60%, mass flow rate= 1lit/80sec,1lit/60sec, 1lit/30sec, inlet Temperature=17°C, input power= 80 watt)

Graph No.13 , 14 and 15 present the variation of Temperature along the thermosyphon for an power 100 watt, filling ratio 60%, three different inlet Temperature (15°C, 16°C and 17°C) and three different mass flow rates (1lit/80sec, 1lit/60sec and 1lit/30sec) respectively.

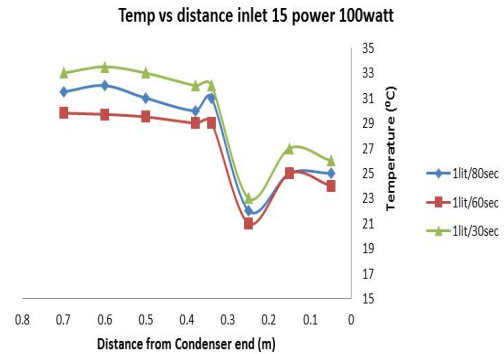

Graph No.13Temperature distribution along the thermosyphon (fill ratio= 60%, mass flow rate= 1lit/80sec,1lit/60sec, 1lit/30sec, inlet Temperature=15°C, input power= 100 watt)

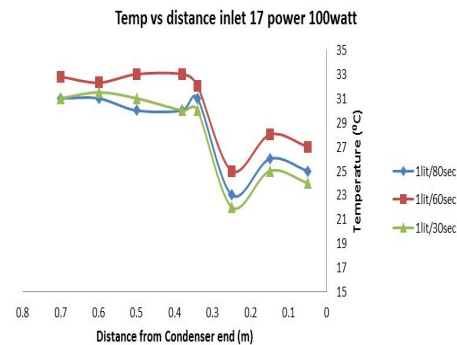

Graph No.14Temperature distribution along the thermosyphon (fill ratio= 60%, mass flow rate= 1lit/80sec,1lit/60sec, 1lit/30sec, inlet Temperature=16°C, input power= 100 watt)

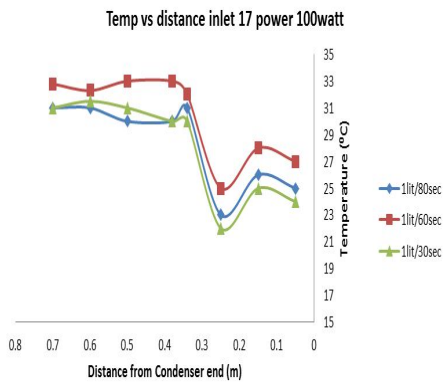

Graph No.15 Temperature distribution along the thermosyphon (fill ratio= 60%, mass flow rate= 1lit/80sec, 1lit/60sec, 1lit/30sec, inlet Temperature=17°C, input power= 100 watt)

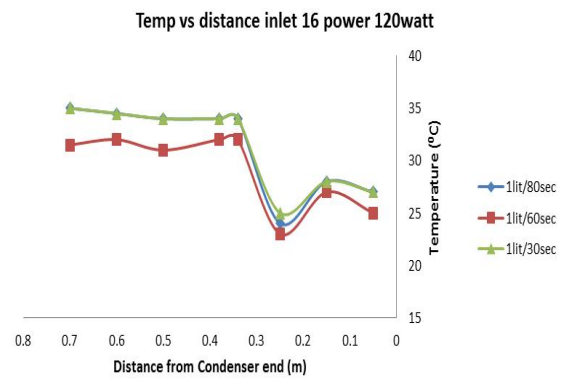

Graph No.17 Temperature distribution along the thermosyphon (fill ratio= 60%, mass flow rate= 1lit/80sec, 1lit/60sec, 1lit/30sec, inlet Temperature=16°C, input power= 120 watt)

Graph No.16, 17 and 18 present the variation of Temperature along the thermosyphon for an power 120 watt, filling ratio 60%, three different inlet Temperature (15°C, 16°C and 17°C) and three different mass flow rates (1lit/80sec, 1lit/60sec and 1lit/30sec) respectively.

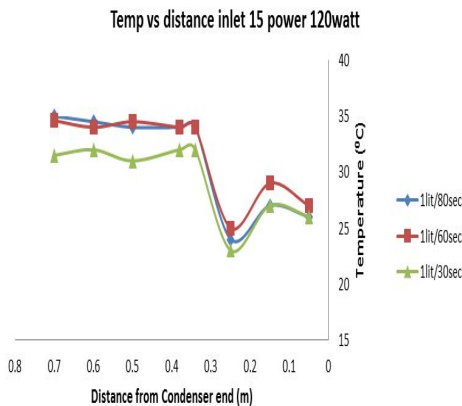

Graph No.16 Temperature distribution along the thermosyphon (fill ratio= 60%, mass flow rate= 1lit/80sec, 1lit/60sec, 1lit/30sec, inlet Temperature=15°C, input power= 120 watt)

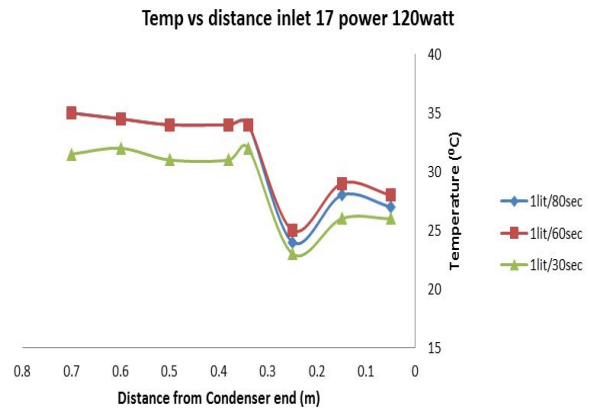

Graph No.18 Temperature distribution along the thermosyphon (fill ratio= 60%, mass flow rate= 1lit/80sec, 1lit/60sec, 1lit/30sec, inlet Temperature=17°C, input power= 120 watt)

C) Graphs of heat pipe having fill ratio 50%

Graph No.19, 20 and 21 present the variation of Temperature along the thermosyphon for an power 80 watt, filling ratio 50%, three different inlet Temperature (15°C, 16°C and 17°C) and three different mass flow rates (1lit/80sec, 1lit/60sec and 1lit/30sec) respectively.

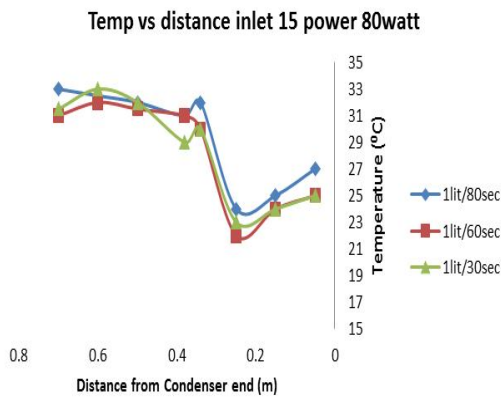

Graph No.19Temperature distribution along the thermosyphon (fill ratio= 50%, mass flow rate= 1lit/80sec,1lit/60sec, 1lit/30sec, inlet Temperature=15°C, input power= 80 watt)

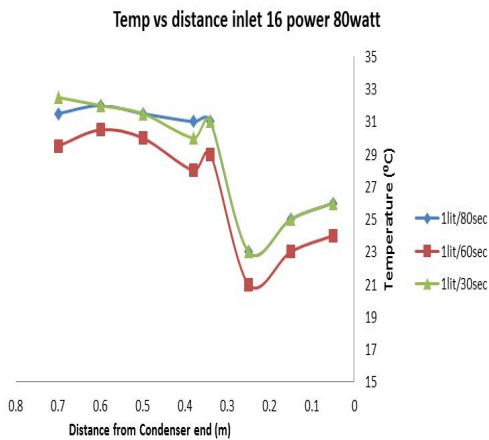

Graph No.20Temperature distribution along the thermosyphon (fill ratio= 50%, mass flow rate= 1lit/80sec,1lit/60sec, 1lit/30sec, inlet Temperature=15°C, input power= 80 watt)

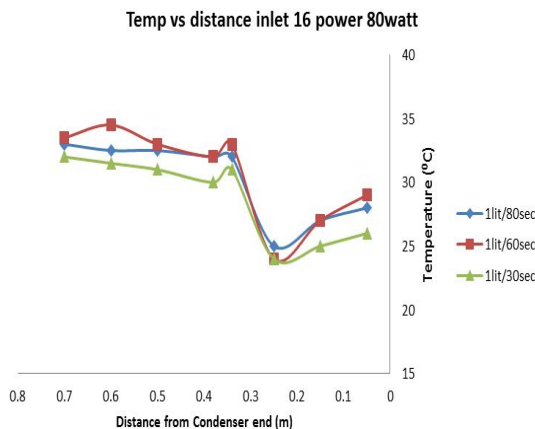

Graph No.21Temperature distribution along the thermosyphon (fill ratio= 50%, mass flow rate=

1lit/80sec,1lit/60sec, 1lit/30sec, inlet Temperature=16°C, input power= 80 watt)

Graph No.22, 23 and 24 present the variation of Temperature along the thermosyphon for an power 100 watt, filling ratio 50%, three different inlet Temperature (15°C, 16°C and 17°C) and three different mass flow rates (1lit/80sec, 1lit/60sec and 1lit/30sec) respectively.

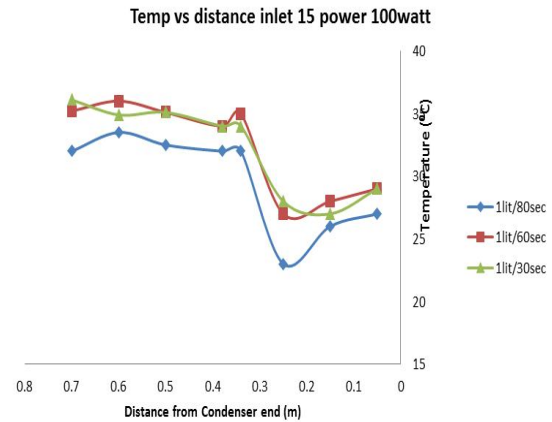

Graph No.22Temperature distribution along the thermosyphon (fill ratio= 50%, mass flow rate= 1lit/80sec, 1lit/60sec, 1lit/30sec, inlet Temperature=15°C, input power= 100 watt)

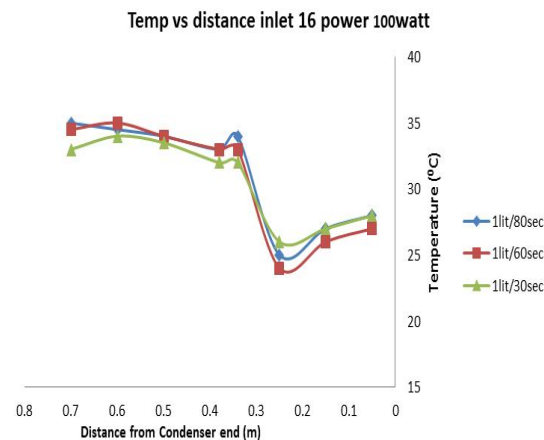

Graph No.23Temperature distribution along the thermosyphon (fill ratio= 50%, mass flow rate= 1lit/80sec, 1lit/60sec, 1lit/30sec, inlet Temperature=16°C, input power= 100 watt)

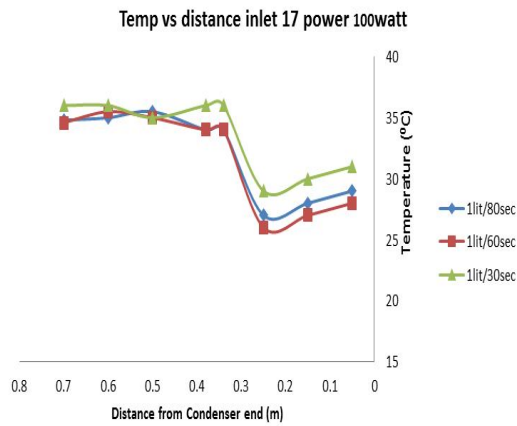

Graph No.24 Temperature distribution along the thermosyphon (fill ratio= 50%, mass flow rate= 1lit/80sec, 1lit/60sec, 1lit/30sec, inlet Temperature=17°C, input power= 100 watt)

Graph No.25, 26 and 27 present the variation of Temperature along the thermosyphon for an power 120 watt, filling ratio 50%, three different inlet Temperature (15°C, 16°C and 17°C) and three different mass flow rates (1lit/80sec, 1lit/60sec and 1lit/30sec) respectively.

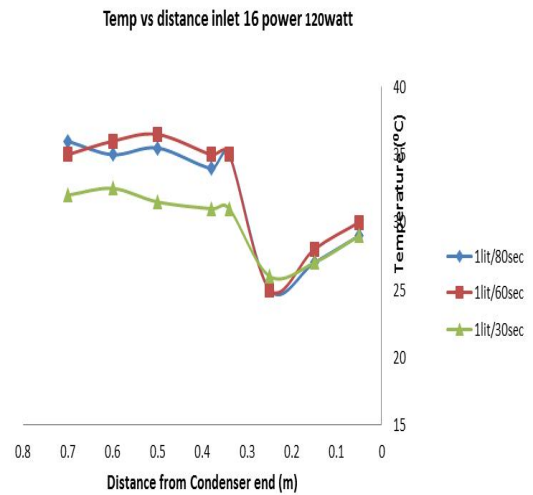

Graph No.26 Temperature distribution along the thermosyphon (fill ratio= 50%, mass flow rate= 1lit/80sec, 1lit/60sec, 1lit/30sec, inlet Temperature=16°C, input power= 120 watt)

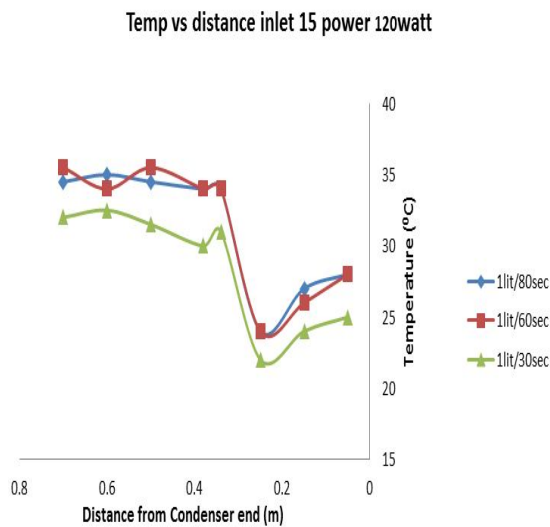

Graph No.25 Temperature distribution along the thermosyphon (fill ratio= 50%, mass flow rate= 1lit/80sec, 1lit/60sec, 1lit/30sec, inlet Temperature=15°C, input power= 120 watt)

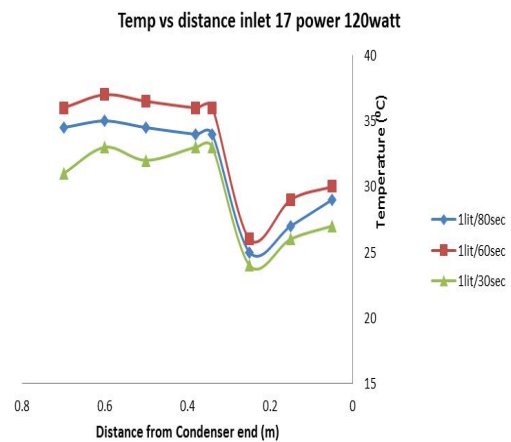

Graph No.27 Temperature distribution along the thermosyphon (fill ratio= 50%, mass flow rate= 1lit/80sec, 1lit/60sec, 1lit/30sec, inlet Temperature=17°C, input power= 120 watt)

V. CONCLUSION

The performance of R-134a thermosyphon is greater with high coolant mass flow rates, high fill ratio, greater Temperature difference between evaporator and Condenser and input power.