

Review on Design and Optimization of Gating and Riser System for Sand Casting Process

J.Yokesh Kumar¹, M.Balakrishnan², S.Gowtham Kumar³, D.Ramesh⁴

^{1, 2, 3, 4} Department of Mechanical Engineering
^{1, 2, 3, 4} Sri Ramakrishna Engineering College, Coimbatore-641022

Abstract- Casting is the one of the suitable economical manufacturing process for producing components of various sizes and shapes. The metal casting process characterized by using sand as the mold material. Over 70% of all metal castings are produced via sand casting process. In addition to the sand a suitable bonding agent (usually clay) is mixed or occurs with the sand. The mold cavities, gating and risering systems are created by compacting the sand around models by the use of patterns. The gating and risering system design plays an important role in the quality. Therefore the design of gating and risering system can be optimized and the optimized design evaluated by casting simulation software. Based on the simulation results the optimized gating and risering system implemented to industries for production.

Keywords- Casting, optimization, solidification, simulation, feeder.

I. INTRODUCTION

The sand casting is the metal casting process by the solidified metal sand and mold material. The molten metal is poured into the sand mold cavity, then solidification of the molten metal within the mold and after solidification. The Sand castings are used to make parts that are comprised of iron, bronze, brass and aluminium in foundries[2]. Some example items manufactured by sand casting process are engine blocks, machine tool bases, cylinder heads, pump housings and valves. The sand molds are formed from wet sand which contains water and organic bonding compounds. This casting can be achieved by mixing of 89% sand, 4% water and 7% clay[1]

The gating and riser design plays an important role in the sand casting process. The gating system of sand casting is designed to direct the liquid to the mould cavity metal for filling. The riser system is direct to counterbalance shrinkage cause by casting solidification. Proper gating and risering design is important for producing sound castings and to improve the yield of the casting. To achieving this the engineers to design filling and feeding system with very accurate performance. The pattern allowances are also affects the quality of the casting. The solidification is the important factor considering for the reason of defects[10]. The selection

of correct allowances helps to reduce the rejections. The flow chart for sand casting methodology is illustrated in fig 1.1.

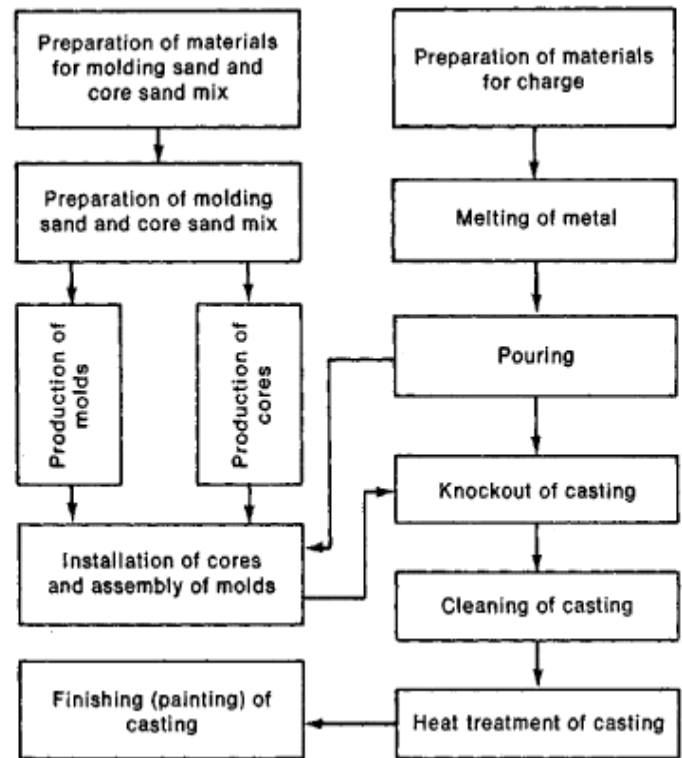

Fig 1.1 Sand casting methodology

1.1 GATING AND RISERING SYSTEM

The following factors are to be considered for the design of gating and risering system to

- ✓ Gas entrapment and absorption
- ✓ Smooth and uniform filling of the casting cavity
- ✓ Solidification shrinkage
- ✓ Slag formation tendency

The proper gating system should fill all the sections approximately the same time. Uniform filling less variation in mechanical properties developed during solidification. This is influenced by flow parameters like pressure, velocity, discharge and geometric parameters in gating system. The gates are designed using the empirical formulas derived using experimental observations. These results are limited to small number of geometries. Therefore the gating designs need to be validated using computer simulations for a particular casting.

Volume reduction occurs during the cooling of the liquid metal after pouring[7]. These contractions will create internal unsoundness. unless a riser, or liquid metal reservoir, provides liquid feed metal until the end of the solidification process. The gating risering system for the sand casting process is illustrated in fig 1.2.1.

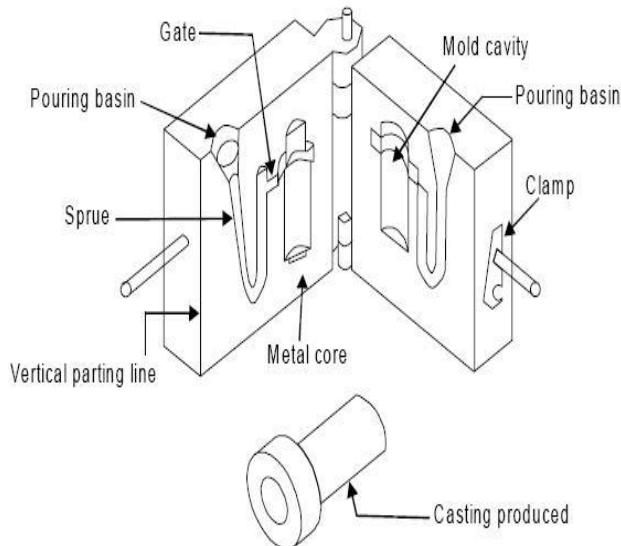

Fig 1.2.1 Gating and Riser system

1.2 MOLD FOR SAND CASTING

A riser, also known as a feeder, is a sand made passage in the mould during ramming the cope. The primary function of the riser (attached with the mould) is to act as a reservoir of molten liquid metal in order to feed molten metal properly to the solidifying casting so that shrinkage cavities are gets rid of during the solidification of a casting. Since shrinkage is found to be one of the common defect in casting. In order to eliminate these defects in the casting, a riser is added to provide enough quantity of liquid metal to compensate liquid shrinkage and solid shrinkage within the casting. Thus a sound casting can be produced without internal shrinkage voids or porosity and external shrinkage defects like sink etc. The mold for sand casting process is illustrated in fig 1.2.2.

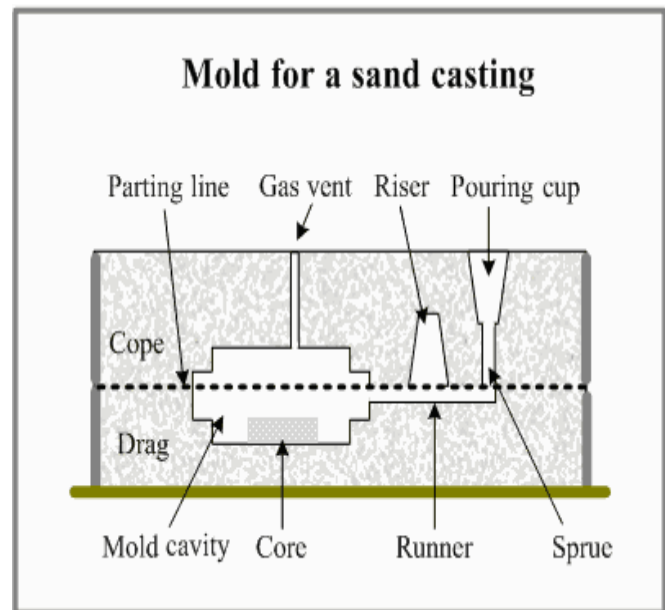

Fig 1.2.2 Mold for sand casting

1.3 TYPES OF RISERS

1. OPEN RISER

Open risers are exposed to the atmosphere and are easy to mould. Open risers help to know whether the mould is completely filled or not. Open risers can be top risers or side risers. Open risers must be large in size. The advantage of a top riser is that the pressure occurred due to the height of the metal causes feeding through thin sections and is preferred for light metals such as aluminium. And in the case of a side riser it should be placed at a higher level for proper feeding which helps the riser to receive hot metal.

2. BLIND RISER

Blind risers are fully enclosed in the mould. A blind riser loses heat slowly and must be smaller in size than an open riser. It is known that risers act as reservoirs of liquid metal for a casting in regions where shrinkage is expected to occur i.e. areas which are the last to solidify. Thus, risers must be made large enough that the riser should solidify completely only after the casting has solidified. If a riser solidifies before the cavity it is to feed, it is useless and produces an unsound casting. A blind riser which is in contact with the mould on all surfaces. Thus a blind riser may be made smaller. A blind riser reduces the energy and time required in removing the riser from the casting.

II. DESIGN AND OPTIMIZATION OF GATING AND RISERING SYSTEM

Before making a design of the gating and risering system, mold, dies, pattern, etc., we studied the existing pattern, casted part and design of gating and feeding system of wear plate. The vertical gate and feeder were used for filling of molten metal into the cavity[1]. Gating and riser are placed symmetrically and makes uniform flow. Feeder was placed on the top of the plate and gate was placed at the bottom of the plate. Casting efficiency is depending upon the perfect gating and riser system design. The material, feeder volume, surface area are consider for the designing. the riser consume more solidification time in casting[13]. The methodologies of cause effective diagram, if –then rules combination, design of experiments are very useful algorithm used for making proper solution and root of causes can be identified[6]. This system design take more time, human power and also cost are compared to other components design in sand casting. because, it will affect the efficiency of casting at most of times[6]. The trial and error methods are used for this design. Because, we could not get accurate result in the first time. We can experimented the design for different values and from that we will choose best dimensions for the design.

2.1 RISERING SYSTEM

According to **Chvorinov's equation,**

$$\text{Freeze time, } t = K [V/SA]^2$$

Where, t = freeze time of casting (sec)
 V = volume of casting (mm³)
 SA = surface area of casting (mm²)
 K = solidification constant (sec/mm²)

since the last metal to freeze would be near the centre of the sphere, where it could not be used to feed a casting. Practicalities dictate the use of cylinders for most risers. So, the cylindrical riser with hemispherical base is used to provide the smallest possible surface area -volume ratio[5].

According to the **PSIRC Method,**

The riser are cooled by circulating air or water. Because, overheat of riser makes the more residual stress and it affects the flow of metal when it passing through the riser. The heat transfer co efficient between the riser top and atmosphere inPSIRC method,

$$h = h_c + \varepsilon_{-}(T_r + T_0)(T_r + T_0^2)$$

where, h is the combined heat transfer of forced convection and radiation of the riser top to the atmosphere, h_c is the forced air or water spray cooling heat transfer coefficient, ε is the

emissivity Boltzmann coefficient. T_r is the surface temperature of the riser, T₀ room temperature. The Biot number is a simple index of the ratio of the heat transfer capability inside and at the surface of a body. if the Biot number is less than 1, the heat transfer is mainly controlled by the surface heat transfer coefficient, which means it is possible to increase the cooling of a riser by increasing its top surface heat removal[8].

2.2 RISER DESIGN PARAMETERS

The riser design involves the deciding of following parameters

- ✚ Total volume of the riser which depends on the shrinkage characteristics of the metal and the shape of the casting etc.
- ✚ The number of risers and their functions in relation to the casting.
- ✚ The types, shape and size of the risers etc.

The gating and risering dimensions are change and simulated with the help of AutoCAST software. The effect of riser and gating on parameters such as filling pattern, pressure and speed, cooling rate and related defects can be find out from the simulation in software.

2.3 GATING SYSTEM

The gate was located at the bottom of the plate and casting setup for filling the molten metal into cavity. Gate and feeder are located at the centerline.

The successive layer of molten metal are laid down by the sprue gate and then filling the cavity. The filling process is explained by **Bernouli Equation,**

$$H_L + P_L / \rho \cdot g + v_L^2 / 2g = H_M + P_M / g + v_G^2 / 2g + h_w$$

$$H_w = \zeta \cdot v_G^2 / 2g$$

where H_L= liquid level in the ladle in m; P_L= pressure on the molten metal in the ladle in N/m²; ρ=density of the molten metal in kg/m³; g=gravitational acceleration 9.8 m/s²; v_L=velocity of the molten metal in ladle in m/s; H_M=liquid level in the mold, m; P_M=pressure on the molten metal in the mold in N/m²; v_G=velocity of the molten metal at the gate in m/s; h_w=loss in kg.m²/s²; ζ=drag coefficient of the sprue.

According to the **Taguchi method,** The gating system

$$(\text{Velocity})^2 = V_x^2 + V_y^2 + V_z^2$$

$$\text{Porosity (\%)} = \text{Vol}_{\text{pores}} / \text{Vol}_{\text{cast}}$$

$$\text{Yield (\%)} = \text{Weight}_{\text{cast}} / (\text{Weight}_{\text{cast}} + \text{Weight}_{\text{gating+riser}})$$

where V_x , V_y , V_z are three component of vector velocity, the product yield is defined by the weight of casting divided by the total weight including the gating and riser system. Porosity is defined as the ratio of the volume of all the pores in the casting to the volume of the whole casting.

Feeding yield and gating yield were calculated by using the following relationship.

- Feeding yield = volume of casting / (volume of casting + volume of feeder)

- Gating yield = Weight of casting / (Weight of casting + Weight of gating)

Temperature distribution was uniform in this case because gates and risers were symmetrically placed. Solidification of molten metal starts immediately after the pouring of molten metal in the cavity of mold and starts when temperature drops below 1050°C. it is shown in reddish blue color. The gating and feeding system for sand casting process is illustrated in fig 2.1.



Fig 2.1 Gating and Feeding system model

III. SOFTWARE USED FOR SAND CASTING PROCESS

Now a days the several different type of software created and used in the industries for designing the components for sand casting process. The some software are explained below that are helpful for understanding their purposes and working.

3.1 AUTO Cast

It assists in designing, modeling, simulating, analyzing and improving cast products. The existing gating and feeding system was checked by using this software. It is used for optimization of feeding system and simulation reduce the casting defects in foundaries. It is used to change gates and riser dimensions. The final results indicated that the design and shape of the gate and the ratio of the gating system have a strong conclusion on the pattern of mold. The sand casting process is illustrated by AUTOcast analysis shown in fig 3.1.1.

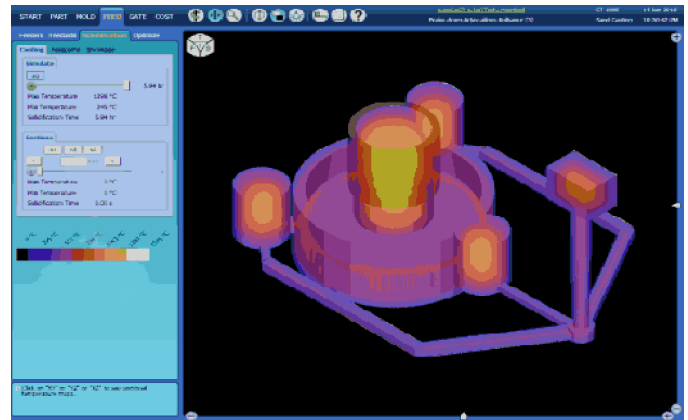

Fig 3.1.1 AUTOCast Analysis

3.2 Pro CAST

Pro CAST is a leading finite element solution for casting process simulation. It can be used for direct chill casting, high pressure and low pressure die casting, investment and shell casting, sand casting, and lost foam casting. Pro CAST is powerful tool to industry for new casting process development, process optimization, and problems solving and die designing. It can predict temperature, liquid metal fluid flow, solidification and re-melting, heat transfer, distortion, cracking, shrinkage and porosity. The sand casting process is illustrated by Procast analysis is shown in fig 3.1.2.

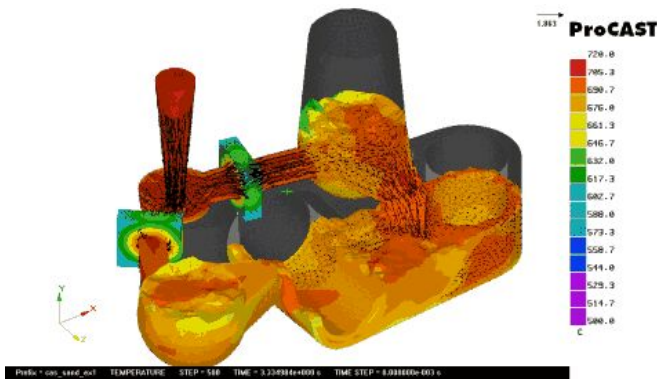

Fig 3.1.2 ProCast Analysis

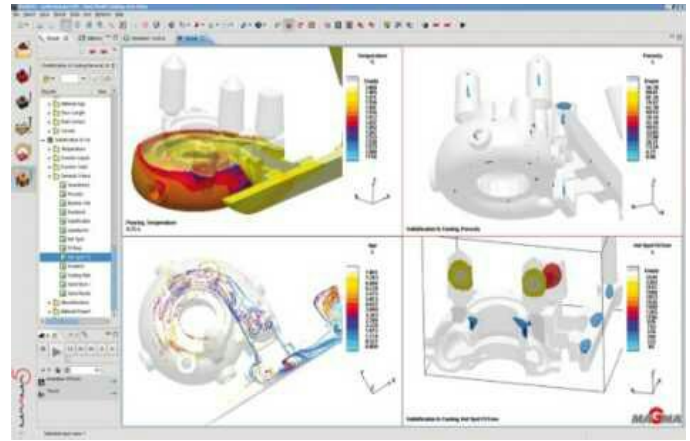

Fig 3.1.4 MAGMASOFT Analysis

3.3 Solid CAST

Design gates, risers and test them out before making your first casting. Solidification modeling helps to shorten lead times, produce higher quality and improve yield. It can simulate processes such as green sand, chemically-bonded sand, investment and permanent mold. With solidCAST can import 3D models from CAD or own models without CAD. The sand casting process is illustrated by Solidcast is shown in fig 3.1.3.

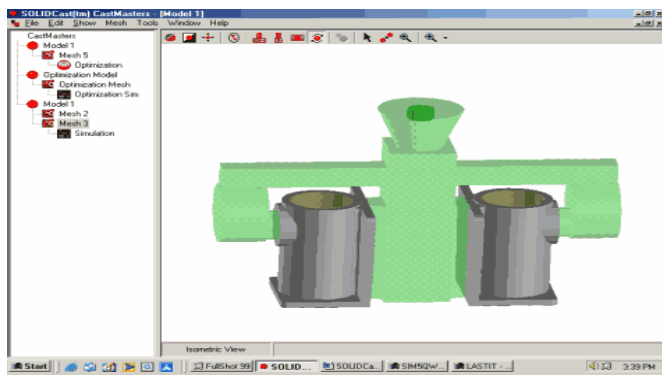

Fig 3.1.3 SolidCast Design

3.4 MAGMASOFT

MAGMASOFT is used for the complete production process from geometry input, design of gating, riser and solidification and finishing process are described and simulated. This allows the user different and simultaneous views and perspective of the component. It is a numerical methodology where the parameters of gating and riser with multiple analysis characteristics and the effect of different gating system design on cavity filling. It is very useful to improve the casting layouts, perfect standard of quality and cost savings. The sand casting process is illustrated by MAMGASOFT analysis is shown in fig 3.1.4.

3.5 Nova Cast

Nova Cast software is used for entire simulation process in casting. Design of gating and feeding system, mould filling, stress calculation, process control system for analyzing, stabilizing and optimizing the foundry process. It is more cost effective software. The sand casting process is illustrated by NovaCast is shown in fig 3.1.5

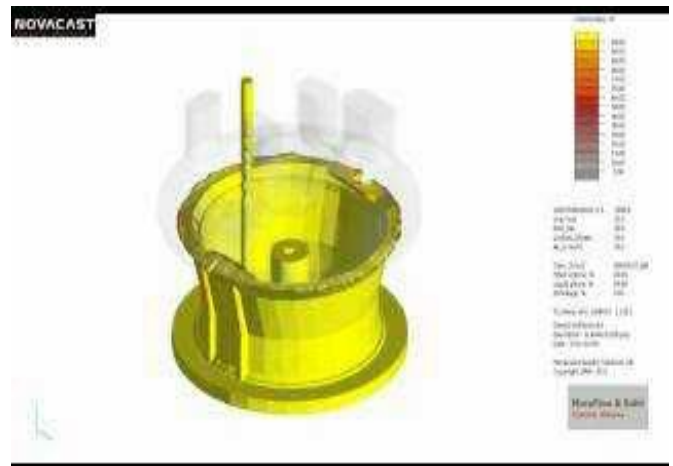

Fig 3.1.5 NovaCast Analysis

IV. DEFECTS AND OVERCOMING IN SAND CASTING

4.1 Blow hole:

It is a cavity defect by slags, oxides. Gases entrapped by solidifying metal on the surface of the casting which results a rounded blowhole as a cavity. The main reasons of blow holes are inadequate core venting, excessive moisture absorption by the cores, low gas permeability of the core sand, moisture content of sand too high, or water released too quickly and gas permeability of the sand too low. This can be overcome by improving core venting and then to provide the

venting channels, ensure core prints are free of dressing. Reduce amounts of gas. Use slow-reacting binder[6]. Reduce quantity of binder. Use a coarser sand if necessary. Apply dressing to cores, thus slowing down the rate of heating and reducing gas pressure. Dry out cores and store dry, thus reducing absorption of water and reducing gas pressure.

4.2 Misrun:

Misrun defect is a kind of incomplete casting defect, which causes the casting uncompleted. The edge of defect is round and smooth. The main reasons of misrun are lack of fluidity in molten metal, faulty design and faulty gating. This will be eliminated by adjusting proper pouring temperature, modifying design and modifying gating system.

4.3 Flash defect:

Flash can be described as any unwanted, excess metal which comes out of the die attached to the cavity or runner. Typically it forms a thin sheet of metal at the parting faces. This defect will be avoided by the is depends upon density of the metal and the weight of the mold fighting it. The solution here is very simple: weight down the mold.

4.4 Shrinkage defect

Shrinkage defects occur when feed metal is not available to compensate for shrinkage as the metal solidifies. Shrinkage defects can be split into two types. open shrinkage defects and closed shrinkage defects. Open shrinkage defects are open to the atmosphere, therefore as the shrinkage cavity forms air compensates. Closed shrinkage defects, also known as shrinkage porosity, are defects that form within the casting. Isolated pools of liquid form inside solidified metal, which are called hot spots. The shrinkage defect usually forms at the top of the hot spots[11]. This kind of defects occurs due to, The density of a die casting alloy in the molten state is less than its density in the solid state. Therefore, when an alloy changes phase from the molten state to the solid state, it always shrinks in size. If the shrinkage porosity is small in diameter and confined to the very centre of thick sections it will usually cause no problems. However, if it is larger in size or else joined together. It can severely weaken a casting[12]. It is also a particular problem for castings which need to be gas tight or water tight.

This will be overcome by, The general technique for eliminating shrinkage porosity is to ensure that liquid metal under pressure continues to flow into the voids as they form.

V. CONCLUSION

Gating and risering system is the main element to provide passage for flow of molten metal and supplies the molten metal to mould cavity during solidification respectively. Hence, the quality of the casting can be affected by the design of gating and risering system. The efficient gating and risering system to be designed by design optimization technique and the optimized design is evaluated by casting simulation software.

Casting simulation is very powerful tool which is used to predict the growth of the process without physically performing the process. This reduces the overall cost of developing the method for new casting by minimizing the time as well as labor involved in it[10]. Simulation also adds confidence to the methods engineer about the functionality of feeding system design.

REFERENCES

- [1] C.M.Choudhari, B.E.Narkhede and S.K.Mahaajan, Methoding and simulation of LM 6 Sand casting for Defect minimization with experimental validation, Global congress on manufacturing and management , Vol 12, pp.1145- 1154, 2014 .
- [2] C.M.Choudhari, B.E.Narkhede and S.K. Mahaajan, Casting design and simulation of cover plate using AutoCAST-X Software for defect minimization with experimental validation, International conference on material processing and characterization, Vol 3, pp.786-797, 2014 .
- [3] D.Metzget, K.Jarrett New and Dantzing, sand surface element for efficient modeling of residual stress in castings. Appl. Math. Model, pp.25:825–42, 2001.
- [4] M. Viqar Mohiuddin, A. Krishnaiah and S. Ferhathullah Hussain, Effect of Composition of Sand Mold on Mechanical Properties and Density of Al-Alloy Casting Using Taguchi Design Approach, M. Viqar Mohiuddin et al. Int. Journal of Engineering Research and Applications, vol.5(1), pp.37-41, March 2015.
- [5] S.Sulaiman and A.M.S.Hamouda, Modelling and experimental investigation of solidification process in sand casting, Journal of Materials Processing Technology, Vol.155–156, pp.1723–1726, 2004.
- [6] Uday.ADabade and Rahul C. Bhedasgaonkar, Casting Defect Analysis using Design of Experiments (DoE)

and computer Aided Casting Simulation Technique, Forty Sixth CIRP Conference on Manufacturing Systems, Vol.7, pp.616 – 621, 2003.

- [7] Harshil Bhatt, Rakesh Barot, Kamlesh Bhatt, Hardik Beravala and Jay Shah, Design Optimization of Feeding System and Solidification Simulation for Cast Iron, 2nd International Conference on Innovations in Automation and Mechatronics Engineering, Vol 14, pp. 357 – 364, 2014.
- [8] Jinwu Kang, Xiaokun Hao, Gang Nie, Haimin Long and Baicheng Liu, Intensive riser cooling of castings after solidification, Journal of Materials Processing Technology, Vol 215, pp.278–286, 2015.
- [9] Sachin L. Nimbalkar and Rajendra S. Dalu, Design optimization of gating and feeding system through simulation technique for sand casting of wear plate, pp.149, 2016.
- [10] Tingli Wang, Shan Yao and Wei Shen, A submerged-gate casting method, Journal of Materials Processing Technology, Vol- 222, pp.21–26, 2015.
- [11] Zhizhong Sun, Henry Hu and Xiang Chen, Numerical optimization of gating system parameters for a magnesium alloy casting with multiple performance Characteristics, journal of materials processing technology, Vol-199, pp.256–264, 2008.
- [12] C. Reilly, N.R. Green, M.R. Jolly and J.-C. Gebelin, “The modelling of oxide film entrainment in casting systems using computational modeling”, Applied Mathematical Modelling, Vol- 37, pp. 8451–8466, 2013.